



KARBONA

PERFORMANCE/STRENGTH/LIGHTNESS

2011
en



www.karbona.com



KARBONA PARTS INC

Tel : 886-4-22950598

Fax : 886-4-22939133

E-mail : karbona@karbona.com

Specification of the Products
and the related Graphic Design
in the catalogue are for your
reference and subject to change.



ZONDA TII



Frame: high modules carbon fiber.

Fork: full carbon fiber monocoque with 1 1/8 integrated with regular contact bearings.

Seatpost: maximum cut off length ISP, measured from top is 70mm. Every square millimeter is designed to reduce energy sapping drag, just pure aerodynamic efficiency.

Internally routed cables and aero positioned brakes for a smooth airflow. Every tube is constructed to maximum aerodynamics and power transfer. Dual tube angles in 74/76 degree with multi position clamp.

Geometry offers the best combination of aero positioning and comfort (Medium and Large sizes sloping)

Handlebar: Sedna 420mm (stem extension available in 90/100/110/120mm)

Saddle: Comfort System in black

Group System: Zero System

Crankset: Matrix EXS Inter (BCD 110mm, length available in 170/172.5/175mm)

Brake Caliper: Vigor

Pedal: Pedal System

Wheelset: Duetto I 50mm tubular

A	B	C	D	E	F	G	H	H1	I	J1	J2	K1	K2	WB
520	519.5	430	58	540	407.5	115	73.5	71.5	45	47	42	52	48	1014.7

ZONDA

Time machine for Triathlon and Time Trail
 Mono-coque HM carbon fiber UD woven in
 glossy Integrated seatpost tube design
 Aero dynamically natural seatpost
 Adjustable Double angles of 76 degree
 and 74 degree

Weight :1450g±20g for medium size
Existing size : M and L to be available

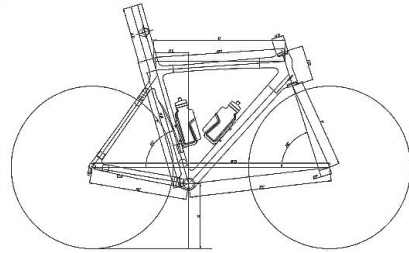

SIZE	A	B	C	D	E	F	G	H	I	J	K	L	REACH	STACK
460	460	410	505	110	70.5°	75°	67	405	970	370	43	574	369	506
490	490	433	520	120	72°	75°	67	405	972	370	43	577	382	516
520	520	476	556	149	73.5°	74.9°	67	405	983	370	43	588	396	554
550	550	490	545	170	73°	73.5°	67	405	974	370	43	579	376	571
580	580	520	575	190	73°	73.2°	67	405	997	370	43	601	394	592



SIZE	ST	TT	SA	HA	B	HT	WB	FC	RC
M	800	535	74.5	70.5	356.27	100	990.31	595.55	400
L	850	558	74.5	70.5	406.26	100	1014.05	619.21	400

PLANET LITE

Head Tube: 1-1/8" ~ 1-1/2"
Size Available: 490/550mm
Frame Weight: approx. 1050g±30g/520mm
Fork Weight: approx. 520g±20g
Bottom Bracket: PF30
Seatpost: Ø27.2
Carbon wave: UD/3K/12K
Compatible with Di2
Color: painted or naked

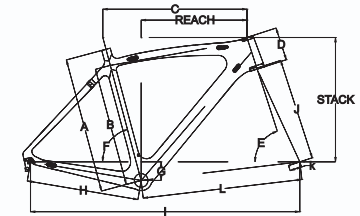

LOGIC LITE

Head Tube: 1-1/2"
Size Available: 440/470/500/530/560/590mm
Frame Weight: approx. 950g±30g
Fork Weight: approx. 400g±20g
Bottom Bracket: BC1.37" & SRAM PF30
Seatpost: Ø31.6mm OD Ø34.9mm

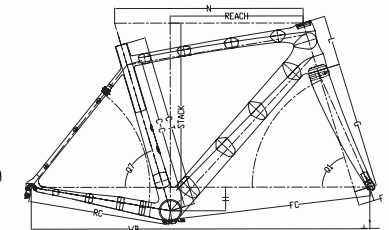

SIZE	S	SP	SC	SL	O	OS	HS	HC	F	OT	WB	FC	RC	G	HD	SEAT POST	AD
500	500	449	74.5	133.6	520	509.8	115	72	370.7	45	968.2	572	406	269	50	SP-02	230
520	520	409	74.5	136	528	518.7	130	72	370.7	45	976.8	580.5	406	269	50	SP-02	230
540	540	489	74	145.4	545	535.8	145	72.5	370.7	45	985.5	589.2	406	269	50	SP-02	230
560	560	509	73.5	154.2	555	546.5	160	72.5	370.7	45	990.9	594.6	406	269	50	SP-02	230
580	580	529	73	163.3	575	566.7	175	73	370.7	45	1001.5	605.1	406	269	50	SP-02	230



ZODIAC

Head Tube : 1-1/8"
Size Available : 500/520/540/560/580mm
Frame Weight : approx.1,145g±30g/540mm
 HM Carbon Monocoque 700C Racing frame
 Seatpost Integrated design

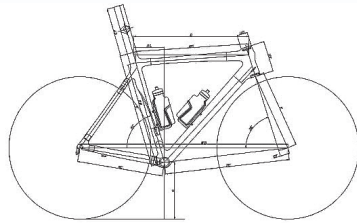

ST	A	B	C	E	F	G	H	I	J	K
440	440	69	498	74.48	72	115	45	404	961	104
490	490	69	517	74.03	72.5	124	45	404	968	121
520	520	69	538	73.52	73	145	45	405	981	133.6
550	550	69	557	73.07	73	175	45	408	999	146
580	580	69	578	72.69	73.3	200	45	408	1012	158



NEO CARBONIO LITE

Head Tube : 1-1/8"
Seatpost Tube : Ø 31.6mm
Size Available : 440,490,520,550,580mm
Frame Weight : approx.980g±30g/520mm
 HM Carbon Monocoque 700C Racing frame.

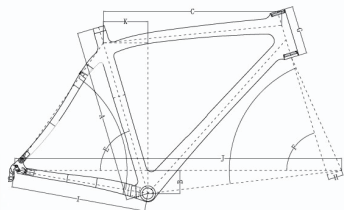

WING LITE

Head Tube: 1-1/8"-1-1/2"
Size Available: 520mm
Frame Weight: approx.980g±30g/520mm
Fork Weight: approx.350g±20g
Bottom Bracket: BSA
Seat post: oval shape
Carbon wavng : 12K
Color: painted or naked

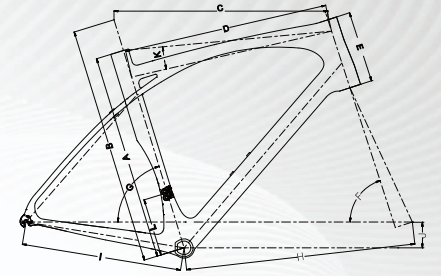

A	B	C	D	E	F	G	H
520	524	545	155	575.3	408	73°	73°

ST	A	B	C	E	F	G	H	I	J
515	515	68	496	75.5	73	90	38	400	990.6
525	525	68	526	75.5	72.5	90	38	400	964.6
545	545	68	556	75.5	72	90	38	400	938.3

NEO TT LITE

Head Tube : 1-1/8"
Size Available : 515/525/545mm
Frame Weight : approx. 1,480g±30g/525mm
 HM Carbon Monocoque Time Trail frame
 Fully Internal cable routing design

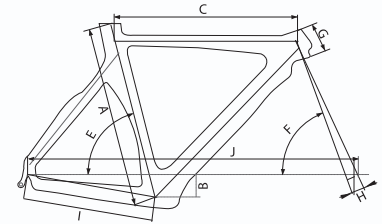

ST	A	B	C	E	F	G	H	I	J
505	505	45	496	75.5	72	90	38	389	938
515	515	45	526	74.0	72.5	90	38	389	985
515	515	45	556	73.3	73	90	38	389	965
525	525	45	576	73.3	73	120	38	389	985

NEO TRACK LITE

Head Tube : 1-1/8"
Size Available : 496/526/556/576mm
Frame Weight : approx. 1,680g±30g/505mm
 HM Carbon Monocoque Track frame

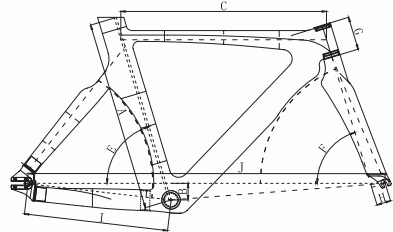

POINT LITE

Head Tube: 1-1/8"
Size Available: 49/52/54/56
Frame Weight: approx. 1420g±30g/520mm
Fork Weight: approx. 520g±20g
Bottom Bracket: BSA

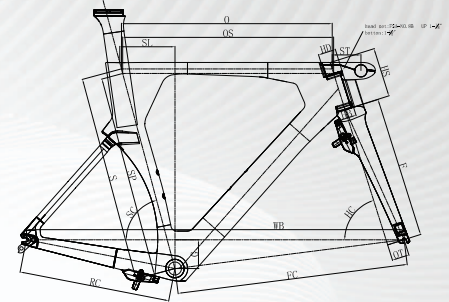

SIZE	S	SP	SC	SL	O	OS	HS	HC	F	OT	WB	FC	RC	G	HD	HB	ST
490	515	500	75°	133	511	511.5	101.5	72.5°	370	45	945.5	562.8	395	75	46	46	75
520	525	510	75°	136	531.5	532	111.5	72.5°	370	45	967	584	395	75	46	46	75
540	542	527	75°	140	550.5	551	129.5	72.5°	370	45	986.5	603.5	395	75	46	46	75
560	561	546	75°	145	569	569.5	148	72.5°	370	45	1006	622.5	395	75	46	46	75

SIZE	C-C	C-T	RC	FC	WB	H	F	G	L	N	STACK	REACH	Q7	Q1	TRAIL
15.5"	334	394	445	635	1073	60	46	506	90	570	609	394	73°	71°	79
17.5"	385	445	445	655	1093	60	46	506	100	590	618	411	73°	71°	79
19"	423	483	445	680	1119	60	46	506	115	615	632	432	73°	71°	79

CHALLENGE 29

Head Tube : 1-1/8"-1-1/2"

Bottom Bracket : BB92

Size Available : 15.5",17.5",19.5"mm

Seat Tube : 34.9mm(for 31.6mm seatpost)

<Weight-17.5">

Frame : 1250g ±30g

HM Carbon Monocoque 29ers MTB frame
Fully internal cable routing design

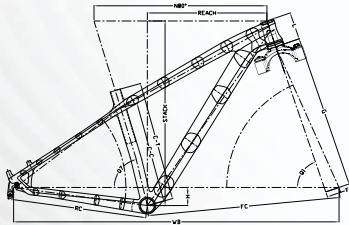

VELO LITE

Mini Size IKIK with 20" wheelset

Head Tube: Tapered 1 1/8-1 1/2

Size Available: 300(C to T)

Frame Weight : approx 1045±50g

Fork Weight: approx 430 ± 12g(with Disc Mount)

Bottom Bracket: BSA1.3T*24t English teeth

Seat Tube: ø27.2mm

Shimano 9 speed

Rake: wall to wall, 50mm

Bottom width of rear stay: 135mm

Appearance: 3K woven in Matt with Karbona logo



ICON LITE

Head Tube : 1-1/8"-1-1/4"

Bottom Bracket : BB30/BB68

Size Available : 48",50",52",54"cm

Set Weight Approx : 1,900gs

Derailleur : Campagnolo 11 speed

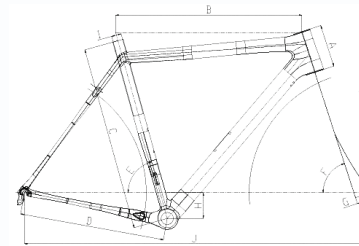

SIZE	A	B	C	D	E	F	G	H	I
500	128	528	515	408	74"	71.5"	45	73	970
515	135	535	530	408	73.7"	72"	45	72	977
530	149	545	545	408	73.7"	72.5"	45	73	983

G2 LITE

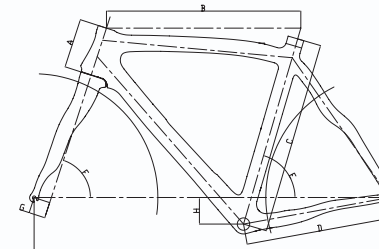

ST	A	B	C	D	E	F	G	H	I	TT	HT	RC	WB
500	368	45	72°	67	74°	525	∅27.4	∅31.8	68	515	110	405	970.6
520	368	45	72°	67	73°	536.3	∅27.4	∅31.8	68	525	120	405	969.4
540	368	42	72°	67	72.5°	547.2	∅27.4	∅31.8	68	535	130	408	969
560	368	42	73°	67	72°	557.5	∅27.4	∅31.8	68	545	145	408	969.3
580	368	45	73°	67	72°	572.8	∅27.4	∅31.8	68	560	160	408	986.2
600	368	45	73°	67	72°	588.5	∅27.4	∅31.8	68	575	175	408	990.8
620	368	45	74°	67	72°	598.2	∅27.4	∅31.8	68	585	195	408	1000.6

GE LITE

Monocoque Frame for Road racing 700C.
Integrated for 46mm

OD : 1/1/8" W/campagnolo bearing
Outer cable routing Interchangeable dropout
Seat Tube : ∅27.2mm
Size : 500/520/540/560/580/600/620mm
Frame weight : around 1400g/540mm

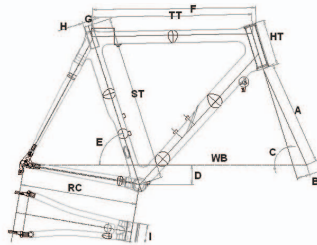

A	B	C	D	E	F	G	H	H1	I	J	L	K
16"	21"	16.53"	1.38"	1.5"	17.13"	4.92"	74"	71"	∅1.81"/1.97"	∅1.65"/1.73"	∅1.08"/1.25"	∅1.25"/1.37"
18"	21.67"	16.73"	1.38"	1.5"	17.72"	4.72"	73"	71"	∅1.81"/1.97"	∅1.65"/1.73"	∅1.08"/1.25"	∅1.25"/1.37"
20"	22.23"	16.73"	1.38"	1.5"	17.72"	4.72"	73"	71"	∅1.81"/1.97"	∅1.65"/1.73"	∅1.08"/1.25"	∅1.25"/1.37"
22"	22.79"	16.73"	1.38"	1.5"	17.72"	5.51"	73"	71"	∅1.81"/1.97"	∅1.65"/1.73"	∅1.08"/1.25"	∅1.25"/1.37"

ATB LITE

HM Carbon Monocoque
SeatpostTube: 31.6mm
Size Available: 300(C to T)
Size : 16", 18", 20", 22"

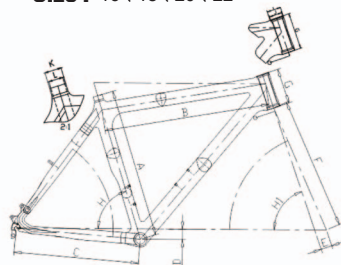

ARGUS

Spec.	Front	Rear
Profile	55mm	55mm
Brake Surface	UD	UD
Spoke Hole	16H	16H
Weight (T)	589g	889g
Weight (C)	744g	1000g
ERD (mm)	633mm	633mm

<Option>

Hub/ Race for shimano or campagnolo.



DUETTO-R

Spec.	Front	Rear
Profile	50mm	50mm
Brake Surface	Carbon	Carbon
Weight(C)	603g±15g	810g±15g
ERD(mm)	546mm	546mm

<Option>

Hub / Race for shimano or campagnolo

Color: Red



MOONSHOOT- II

Spec.	Front	Rear
Profile	60mm	60mm
Brake Surface	Carbon	Carbon
Weight(C)	752g±15g	970g±15g
ERD(mm)	532.7mm	532.7mm

<Option>

Hub / Race for shimano or campagnolo

Color: Green



DISC AIR

This Disc-Air is made by using the bladder molding system which enables the maximum inner molding pressure to compact the carbon lamination and provide more rigidity.

This process in making the Disc-Air lighten the weight by at least 200-400 grams approximately and less expensive compared the way by using foam core or nomex honeycomb structure.

Available for road and for track



CHARISMA

Spec.	Front	Rear
Profile	90mm	90mm
Brake Surface	carbon	carbon
Spoke Hole	20H	24H
Weight (C)	880g	1080g
ERD (mm)	473.7mm	473.7mm

<Option>

for Hub / Race / Crest

Mission for ironman Triathlon competition and TT courses its stiffness coefficient enables the rider to convert muscle effort into toward motion without wasted energy.



MOONSHOOT

Spec.	Front	Rear
Profile	58mm	58mm
Brake Surface	aluminum	aluminum
Spoke Hole	20H	24H
Weight (C)	950g	1150g
ERD (mm)	532.7mm	532.7mm

<Options>

for Hub / Race / Crest

Mission for Road and Time Trail

Selected by aluminum bed over all carbon bed For improved braking and to protect the tire and avoid flats.

Stiff and compliant of Karbona's proven 58mm clincher which hold high cruising speed with less effort.



EXTRA LITE

Spec.	Front	Rear
Profile	55mm	55mm
Brake Surface	UD	UD
Spoke Hole	16H	16H
Weight (C)	860g	1000g
ERD (mm)	633mm	633mm

<Options>

for Hub / Race for shimano or campagnolo.



MINI VELO

Spec.	Front	Rear
Profile	38mm	38mm
Brake Surface	Carbon	Carbon
Spoke Hole	20H	24H
Weight (C)	460g	630g
ERD (mm)	347mm	347mm

<Options>

Clincher only.

Hub / Race for shimano or campagnolo



DUETTO-II

Spec.	Front	Rear
Profile	38mm	38mm
Spoke Hole	20H	24H
Weight (T)	613g	828g
Weight (C)	715g	930g
ERD (mm)	568mm	568mm

<Options>

Tubular / Clincher



WINDSTOPPER

Spec.	Front	Rear
Profile	58mm	58mm
Brake Surface	carbon	carbon
Spoke Hole	20H	24H
Weight (C)	960g	1130g
ERD (mm)	532.7mm	532.7mm

<Options>

Tubular / Clincher

Mission for road and Time Trail

Designed for speed and all round performance

Windstopper has built for demonic speed in

Triathlons and Time Trials.



DUETTO-I

Spec.	Front	Rear
Profile	50mm	50mm
Spoke Hole	20H	24H
Weight (T)	645g	860g
Weight (C)	743g	958g
ERD (mm)	546mm	546mm

<Options>

Tubular / Clincher



TIME SPEED

Spec.	Front	Rear
Profile	85mm	85mm
Brake Surface	carbon	carbon
Spoke Hole	20H	24H
Weight (T)	760g	1070g
Weight (C)	840g	1150g
ERD (T/mm)	468.5	468.5
ERD (C/mm)	469mm	469mm

<Options>

for Hub / Race / Crest

Combining the new carbon matrix hubs and track hubs with the aerodynamics of Karbona's proven 85mm carbon tubular deep rims and bladed spokes make the time trail carbons the ultimate quality weight race wheels.



GLAMOUR

Spec.	Front	Rear
Profile	50mm	50mm
Brake Surface	carbon	carbon
Spoke Hole	18H	20H
Weight (T)	770g	950g
Weight (C)	785g	965g
ERD (mm)	N/A	N/A

The Glamour is made of high modular carbon fibre combines with a special assembling technology by aluminum aerodynamic designed spokes. This wheel has a complete new concept and has unrivalled achievement.



SUPREMACY



Spec.	Front	Rear
Profile	55mm	55mm
Spoke Hole	16H	16H
Brake Surface	Super RT	Super RT
Weight (C)	860g	1050g
ERD (mm)	633mm	633mm

<Options>

Hub / Race for Shimano or Campagnolo

XENA-TT

HM Carbon Monocoque Handlebar for Time Trial
3K, 12K weave gloss finished

Fork clamp: 1-1/8"

Width(C to C): 420mm

Extension Available: 90/100/110/120 mm

Weight: approx. 492±15g



IRONMAN

Professional Design Aero Bar
HM Carbon Monocoque Construction
for Triathlons

Width (C to C): 400mm

Weight: 590g±20g

Stack: 10mm



CITY 2 SUPER

HM Carbon Monocoque
MTB Riser Bar
3K weave glossy

Barbore: Ø 31.8mm
Width : 640mm
Rise : 20mm
Weight : approx. 175 ± 10g



LIFE 2 SUPER

HM Carbon Monocoque
MTB Straight Bar
3K weave glossy

Barbore : Ø 31.8mm
Width : 580mm
Sweep : 6° back sweep / 0° up sweep
Weight : approx. 175g ± 10g



SWEET ZONE

HM Carbon Monocoque Handlebar
for road 3K, 12K woven glossy

Length Available : 400, 420, 440mm
Barbore : 31.8mm
Weight : approx. 260g±10g / 420mm



COMP ELITE

HM Carbon Handlebar for Road
3K woven glossy appearance

Length Available : 400, 420, 440mm
Barbore : Ø 31.8mm
Weight : approx. 315g ± 15g



TWIN PEAK

Carbon Matrix Handlebar for Road
AL6061 + 6K woven glossy appearance

Length Available : 400, 420, 440mm
Barbore : Ø31.8mm
Weight : approx. 262g±15g



COUGAR

HM Carbon Handlebar for Road Palm
Shape Design 3K or 12K woven glossy

Length Available : 400, 420, 440mm
Barbore : 31.8mm
Weight : approx. 250g±15g

SEDNA-X

Aerobar for Time Trial and Road
Carbon fiber with 3K weave glossy
Monocoque construction

Barbore : 31.8mm
Width(C to C) : 420mm
Weight : approx. 750±15g





KSP-05

Road Seatpost
 HM Carbon Monocoque Material
 Single bolt design w/ glossy finished

OD: Ø31.6mm available
Lenth: 320mm
Weight : approx.187.5g±5g



KSP-06

MTB Seatpost
 Carbon post w/ Alumium Cap

OD: Ø31.6mm available
Lenth: 350mm
Weight: approx. 240g±5g

KSP-25

Road Seatpost
 HM Carbon Monocoque Material
 3K or 12K woven glossy

Carbon Aero Shape
 Seatpost for road
 2 Fixing bolts micro adjust clamp
OD: Ø27.2mm or Ø350mm

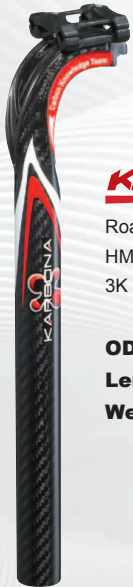

KSP-10

Road Seatpost
 HM Carbon Muscle Design
 3K or 12K woven glossy

OD: Ø27.2mm or Ø31.6mm available
Lenth : 350mm
Weight : approx. 178.8g±10g



KSP-18

Road Seatpost
 HM Carbon Monocoque Material
 3K or 12K woven glossy

OD: Ø27.2mm available
Lenth : 320mm
Weight : approx. 198g±10g



KSP-23

Road Seatpost
 HM Carbon Monocoque
 W/ 3D forged one piece design
 3K or 12K woven glossy

OD: Ø27.2mm or Ø31.6mm available
Lenth : 350mm
Weight : approx. 223g±10g



KSP-88

For Road and TT
 Monocoque stronger and
 aero shape construction.
 2bolts more micro adjustable
 Carbon clamp.

OD : 27.2 / 31.6mm,L/350mm
Weight : approx. 185g±5g

FLYING FISH

HM Carbon Monocoque Stem for Road
W/ 3K woven glossy finished

Steerer Tube : 1-1/8"

Angle : -5°

Barbore : Ø31.8mm

Extension Available : 90, 100, 110, 120mm

Weight : approx. 138.0g±5g / 90mm



KRX-12

Carbon wrapped stem for Road & MTB
Flip-flop w/ 3K tube & cap carbon wrapped.

Steerer Tube : 1-1/8"

Angle : ±10°

Barbore : Ø31.8mm

Extension Available: 90, 100, 110,
120, 130mm

Weight : approx. 175.0g±5g / 110mm



KRX-15

Carbon wrapped stem for Road & MTB
Flip-flop w/ 3K tube & cap carbon wrapped.

Steerer Tube: 1-1/8"

Angle : ±10°

Barbore : Ø31.8mm

Extension Available : 90, 110mm

Weight : approx. 181.0g±5g / 110mm



KRX-90

Carbon Matrix stem for Road & MTB
3D forged CNC Machined w/ flip-flop.
AL 7075 w/ 3K tube&cap carbon wrapped.

Steerer Tube : 1-1/8"

Angle : ±5°

Barbore : Ø31.8mm

Extension Available : 80, 90, 100, 110, 120mm

Weight: approx. 128.6g±5g / 90mm



WENDY

Carbon fork 26" for MTB
AL7075 steerer w/ full carbon tubes.

W/ 3K woven glossy finished

2D forged AL 6061 dropouts

Steerer Tube : 1-1/8"

Size Available : Super-445mm(26")

Weight : approx. 1,040g±15g /26"



CYCLOCROSS DISC

Cyclocross fork

AL7075 steerer w/ full carbon tubes
W/ 3K or 12K woven glossy finished

Steerer Tube : 1-1/8"

Integrated 46mm dual pivots

For V-brake and Disc brake system

Weight : approx. 740g±15g



ULTRA III

For 700c race fork

HM carbon fiber monocoque
3K woven carbon in black glossy
45mm integrated

Weight : approx. 740g±15g



CORSA-ELITE

Monocoque full carbon racing fork
3K, 12K, UD woven glossy finished

Steerer Tube : 1-1/8"

Offset : 45mm

Weight : approx. 375±15g



RACING SPEED

Racing fork full carbon monocoque
Aero dynamic construction design

Offset : 45mm

Steerer Tube : 1-1/8"

Weight : 385g±15g



**MATRIX EXS
INTER COMPACT**

Carbon Matrix crankset w/ B.B. Integrated type W/ AL7075 CNC Chainrings.

BCD : 110mm
Chainrings : 50/34t
Length Available : 170, 175mm
Weight : approx. 834.6g±15g



EX-INTER

HM Carbon crankset w/ B.B. Integrated type.

BCD : 130mm
Chainrings : 53/39t (130)
Length Available : 170, 172.5, 175mm
Weight : approx. 714g±15g



VIGOR

Carbon Matrix dual pivot
 Brake caliper with QR.
 Carbon Matrix cartridge
Weight :174g(Front) / 169g(Rear)

SCOPE

Use like steer spacer with carbon tubing for front light, speed meter.

For Road

Material : AL-7075 Tube: Carbona
Color : Black / Sliver / Red / Gold
Weight : 65 gms



For MTB

Material : AL-7075 Tube: Carbona
Color : Black / Sliver / Red / Gold
Weight : 78 g



PEDAL SYSTEM

HM Carbon fiber pedal for road

Body: Full Carbon Fiber
Spindle: CNC machined Cr-Mo
 CNC machined Ti
Size: 85*93mm
Weight: 205g/pr.



KUGA

Use the pedal through the hole of stand(or kickstand) and then install into the screw-hole of crank.

Material :AL-7075
Width : 33-39mm
Color :Black / Sliver
Weight :75 gms



COMFORT SUPER

1. Top main body: synthetic resin(super Nylon composite) by injection.
2. Rail: carbon fiber.
3. Colors available: Black, Red, White, Yellow, Blue.
4. Weight: 105g \pm 5g.
5. Patent design: high performance air flow dynamic design to cool 2-5 c degree down and shocking absorb.
6. Super coating tech to minimize the impact of vibration and anti-slips.
7. Lab. test to comply with EN standard.



SADDLEWORK

Carbon Base with Synthetic leather upper & High Performance Sponge

Color : Rad

Weight : approx. 189g \pm 10g



COMFORT SYSTEM-X



COMFORT PRO

1. Top main body: synthetic resin(super Nylon composite) by injection.
2. Rail: carbon fiber.
3. Colors available: Black, Red, White, Yellow, Blue.
4. Weight: 95g \pm 5 g.
5. Patent design: high performance air flow dynamic design to cool 2-5 c degree down and shocking absorb.
6. Super coating tech to minimize the impact of vibration and anti-slips.
7. Lab. test to comply with EN standard.



COMFORT SYSTEM

HM Carbon fiber light weight saddle
Various colors available

Base : full carbon fiber

Rails : carbon rails

Color Available : Black, Red, Blue, Green

Weight : approx. 123g \pm 10g



CARRIER

HM Carbon fiber carrier
Multifunction for time trial/road
Weight : approx. 88g \pm 10g

PLUG

Carbon ahead cap
One Size fits to all (22.5~25.4mm)
Weight : approx. 30g \pm 5g



LEVA

Carbon lever for road and cyclocross.
Carbon fiber lever and cold forged alloy bracket
Expandable plug clamp design for extension bar.
Clip ID : 19.6/20.6mm
Weight : approx. 118g \pm 10g



SPACER

HM Carbon Spacer
OD : \varnothing 28.6 for 1-1/8" fork tube
Depth Available : 3, 5, 10, 15, 20, 25mm
Weight : 4.4g /10mm



NOOSE

Carbon Bearing Cover
OD : 46mm
Depth Available : 8.5, 15, 20, 25mm
Weight : 9.0g /15mm; 17.2g /25mm





CRESCENT

HM Carbon Water Bottle Cage
3K Woven Glossy Finished
Color Available : Black
Weight : approx.26±5g



THRONE

HM Carbon Water Bottle Cage
3K Woven Glossy Finished
Color Available : Black
Weight : approx.24g±5g



ROSELINE

HM Carbon Water Bottle Cage
3K/Marble woven Glossy finished
Color Available : Black(marble) Red(3K)
Weight : approx. 33.4g ± 5g



ECLIPSE

HM Carbon Water Bottle Cage
3K Woven Glossy Finished
Color Available : Black
Weight : approx.25±5g



WING

HM Carbon Water Bottle Cage
3K woven Glossy finished
Color Available : Black
Weight : approx. 27.2g ± 5g



EXTREME

HM Carbon Water Bottle Cage
Marble woven Glossy finished.
Weight : approx. 33.4g±5g



CASTLE

HM Carbon Water Bottle Cage
Marble woven glossy finished
Weight : approx. 21.2g±5g



GUESS

HM Carbon Water Bottle Cage
Marble woven Glossy finished
Weight : approx. 20g ± 5g

GEMINI-X

Full Carbon RQ For Road

Material: Carbon Cam+Carbon stem

Appearance: UD in glossy

Weight: 26.8g±5g



SKEWERS

Quick Release skewer for ROAD

Made from AL7075 fully CNC Machined
w/ 64 Ti axle Super Light weight design

Axle Length : 100mm for front / 130mm for rear

Color Available : Black, Red, Blue, Gold,
Silver anodized

Weight : approx. 46g ± 5g /130mm



GEMINI

Quick Release skewer for ROAD

Carbon cam + Titanium axle

Axle Length : 100mm for front / 130mm for rear

Weight : approx. 43.8g±5g/110mm
45.6g±5g /130mm



CLAMP-Q

Clamps for ROAD and MTB

Made from AL7075 fully CNC Machined
W/ quick release design

Clamp Sizes : 31.8mm / 34.9mm

Color Available : Black, Red, Blue, Gold,
Silver anodized

Weight : approx. 22.4g/31.8mm; 22.7g/34.9mm

